



Grade 80 Toebehoren volgens EN 1677 / Grade 80 Accessories according to EN 1677

37. Aanlashaken met klep /
Weld hooks with latch



38. Aanlasogen /
D-rings



39. Aanlasogen met veer /
D-rings with spring

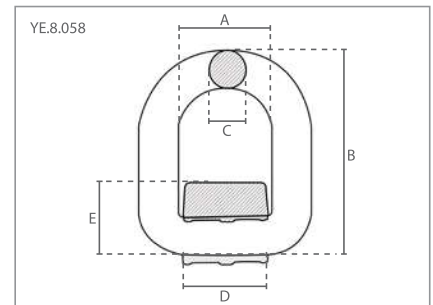
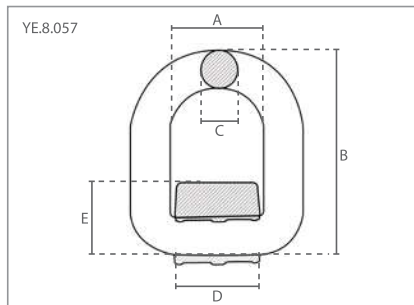
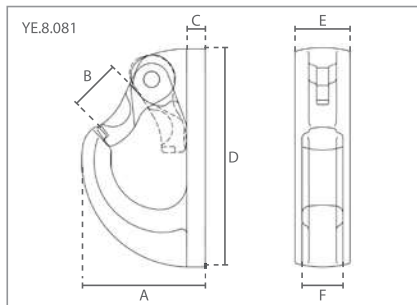

37 Specificaties / Specifications			Afmetingen / Dimensions (mm)					
Artikel nummer Article code	Capaciteit / Capacity ton	Gewicht / Weight kg	A	B	C	D	E	F
YE.8.081.01	1.00	0.4	53	18	9	87	20	15
YE.8.081.02	2.00	0.6	64	26	10	112	27	20
YE.8.081.03	3.00	0.9	75	30	11	128	32	26
YE.8.081.05	5.00	1.8	93	35	20	160	40	30
YE.8.081.08	8.00	3.0	106	40	16	180	51	40
YE.8.081.12	12.00	6.2	140	51	24	236	61	51
YE.8.081.20	20.00	11.5	192	70	24	292	85	60

38 Specificaties / Specifications			Afmetingen / Dimensions (mm)				
Artikel nummer Article code	Capaciteit / Capacity ton	Gewicht / Weight kg	A	B	C	D	E
YE.8.057.01	1.12	0.4	41	79	13	37	35
YE.8.057.02	2.00	0.5	42	88	14	40	37
YE.8.057.03	3.15	0.7	45	94	17	43	40
YE.8.057.05	5.30	1.5	55	118	22	61	52
YE.8.057.20	20.00	15.4	149	286	46	125	84

39 Specificaties / Specifications			Afmetingen / Dimensions (mm)				
Artikel nummer Article code	Capaciteit / Capacity ton	Gewicht / Weight kg	A	B	C	D	E
YE.8.058.01	1.12	0.4	41	79	13	37	34
YE.8.058.02	2.00	0.5	42	88	14	40	36
YE.8.058.03	3.15	0.7	45	94	17	43	39
YE.8.058.05	5.30	1.5	55	118	22	51	49
YE.8.058.08	8.00	2.5	70	141	27	71	54
YE.8.058.15	15.00	5.8	97	188	34	90	72
YE.8.058.20	20.00	15.4	149	286	46	125	84